

# GaAs-IR-Lumineszenzdioden (950 nm) in SMR<sup>®</sup> Gehäuse

## GaAs Infrared Emitters (950 nm) in SMR<sup>®</sup> Package

**SFH 4510**  
**SFH 4515**



SFH 4510



SFH 4515

### Wesentliche Merkmale

- GaAs-LED mit sehr hohem Wirkungsgrad
- SMR<sup>®</sup> (Surface Mount Radial) Gehäuse
- Für Oberflächenmontage geeignet
- Gegurtet lieferbar
- Gehäusegleich mit Fotodiode SFH 2500/ SFH 2505
- Hohe Zuverlässigkeit
- Gute spektrale Anpassung an Si-Fotoempfänger
- UL-Freigabe

### Anwendungen

- IR-Fernsteuerung von Fernseh- und Rundfunkgeräten, Videorecordern, Lichtdimmern
- Gerätefernsteuerungen für Gleich- und Wechsellichtbetrieb
- Sensorik
- Diskrete Lichtschranken
- Diskrete Optokoppler

### Features

- Very highly efficient GaAs-LED
- SMR<sup>®</sup> (Surface Mount Radial) package
- Suitable for surface mounting (SMT)
- Available on tape and reel
- Same package as photodiode SFH 2500/ SFH 2505
- High reliability
- Spectral match with silicon photodetectors
- UL-approval

### Applications

- IR remote control of hi-fi and TV-sets, video tape recorders, dimmers
- Remote control for steady and varying intensity
- Sensor technology
- Discrete interrupters
- Discrete optocouplers

Typ Type	Bestellnummer Ordering Code	Gehäuse Package
SFH 4510	Q62702-P1798	5-mm-SMR <sup>®</sup> -Gehäuse (T 1 3/4), schwarzes Epoxy-Gießharz, Anschlüsse (SFH 4510 gebogen, SFH 4515 gerade) im 2.54-mm-Raster (1/10"), Kathodenkennzeichnung: siehe Maßzeichnung. 5 mm SMR <sup>®</sup> package (T 1 3/4), black-colored epoxy resin, solder tabs (SFH 4510 bent, SFH 4515 straight) lead spacing 2.54 mm (1/10"), cathode marking: see package outline.
SFH 4515	Q62702-P1821	

**Grenzwerte** ( $T_A = 25\text{ °C}$ )**Maximum Ratings**

Bezeichnung Parameter	Symbol Symbol	Wert Value	Einheit Unit
Betriebs- und Lagertemperatur Operating and storage temperature range	$T_{op}; T_{stg}$	- 40 ... + 100	°C
Sperrspannung Reverse voltage	$V_R$	5	V
Durchlaßstrom Forward current	$I_F$ (DC)	100	mA
Stoßstrom, $t_p = 10\text{ }\mu\text{s}$ , $D = 0$ Surge current	$I_{FSM}$	3	A
Verlustleistung Power dissipation	$P_{tot}$	150	mW
Wärmewiderstand Sperrschicht - Umgebung bei Montage auf FR4 Platine, Padgröße je $20\text{ mm}^2$ Thermal resistance junction - ambient mounted on PC-board (FR4), padsizes $20\text{ mm}^2$ each	$R_{thJA}$	300	K/W

**Kennwerte** ( $T_A = 25\text{ °C}$ )**Characteristics**

Bezeichnung Parameter	Symbol Symbol	Wert Value	Einheit Unit
Wellenlänge der Strahlung Wavelength at peak emission $I_F = 100\text{ mA}$	$\lambda_{peak}$	950	nm
Spektrale Bandbreite bei 50% von $I_{max}$ Spectral bandwidth at 50% of $I_{max}$ $I_F = 100\text{ mA}$	$\Delta\lambda$	55	nm
Abstrahlwinkel Half angle	$\varphi$	$\pm 14$	Grad deg.
Aktive Chipfläche Active chip area	$A$	0.09	$\text{mm}^2$
Abmessungen der aktiven Chipfläche Dimension of the active chip area	$L \times B$ $L \times W$	$0.3 \times 0.3$	mm
Schaltzeiten, $I_e$ von 10% auf 90% und von 90% auf 10%, bei $I_F = 100\text{ mA}$ , $R_L = 50\text{ }\Omega$ Switching times, $I_e$ from 10% to 90% and from 90% to 10%, $I_F = 100\text{ mA}$ , $R_L = 50\text{ }\Omega$	$t_r, t_f$	0.5	$\mu\text{s}$

**Kennwerte** ( $T_A = 25\text{ °C}$ )**Characteristics** (cont'd)

Bezeichnung Parameter	Symbol Symbol	Wert Value	Einheit Unit
Kapazität Capacitance $V_R = 0\text{ V}, f = 1\text{ MHz}$	$C_o$	25	pF
Durchlaßspannung Forward voltage $I_F = 100\text{ mA}, t_p = 20\text{ ms}$ $I_F = 1\text{ A}, t_p = 100\text{ }\mu\text{s}$	$V_F$ $V_F$	1.30 ( $\leq 1.5$ ) 2.30 ( $\leq 2.8$ )	V V
Sperrstrom, Reverse current $V_R = 5\text{ V}$	$I_R$	0.01 ( $\leq 1$ )	$\mu\text{A}$
Gesamtstrahlungsfluß, Total radiant flux $I_F = 100\text{ mA}, t_p = 20\text{ ms}$	$\Phi_e$	22	mW
Temperaturkoeffizient von $I_e$ bzw. $\Phi_e$ , $I_F = 100\text{ mA}$ Temperature coefficient of $I_e$ or $\Phi_e$ , $I_F = 100\text{ mA}$	$TC_I$	- 0.5	%/K
Temperaturkoeffizient von $V_F$ , $I_F = 100\text{ mA}$ Temperature coefficient of $V_F$ , $I_F = 100\text{ mA}$	$TC_V$	- 2	mV/K
Temperaturkoeffizient von $\lambda$ , $I_F = 100\text{ mA}$ Temperature coefficient of $\lambda$ , $I_F = 100\text{ mA}$	$TC_\lambda$	0.3	nm/K

**Strahlstärke  $I_e$  in Achsrichtung**gemessen bei einem Raumwinkel  $\Omega = 0.001$  sr**Radiant Intensity  $I_e$  in Axial Direction**at a solid angle of  $\Omega = 0.001$  sr

Bezeichnung Parameter	Symbol	Werte Values	Einheit Unit
Strahlstärke Radiant intensity $I_F = 100$ mA, $t_p = 20$ ms	$I_{e \text{ typ}}$ $I_{e \text{ min}}$	50 $\geq 25$	mW/sr mW/sr
Strahlstärke Radiant intensity $I_F = 1$ A, $t_p = 100$ $\mu$ s	$I_{e \text{ typ}}$	450	mW/sr

**Relative Spectral Emission**

$I_{rel} = f(\lambda)$

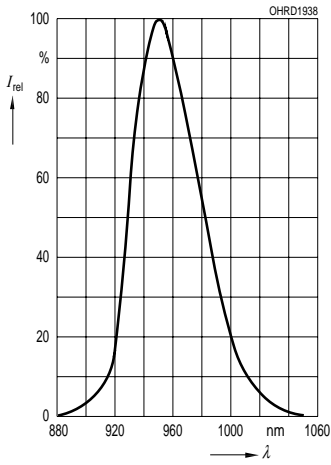

**Radiant Intensity**  $\frac{I_e}{I_{e 100 \text{ mA}}} = f(I_F)$

Single pulse,  $t_p = 20 \mu\text{s}$

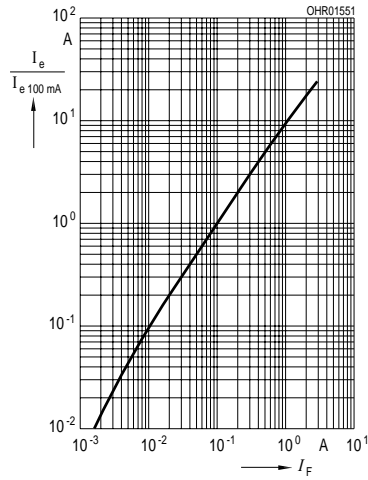

**Max. Permissible Forward Current**

$I_F = f(T_A)$

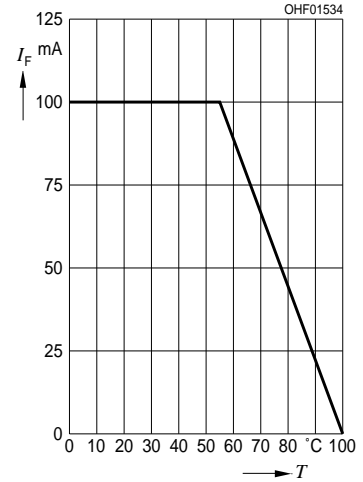

**Forward Current**

$I_F = f(V_F)$ , single pulse,  $t_p = 20 \mu\text{s}$

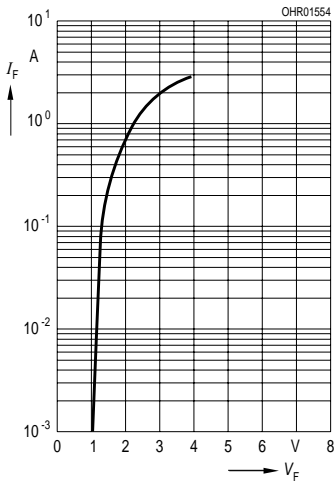

**Permissible Pulse Handling Capability**

$I_F = f(\tau)$ ,  $T_A = 25 \text{ }^\circ\text{C}$ , duty cycle  $D = \text{parameter}$

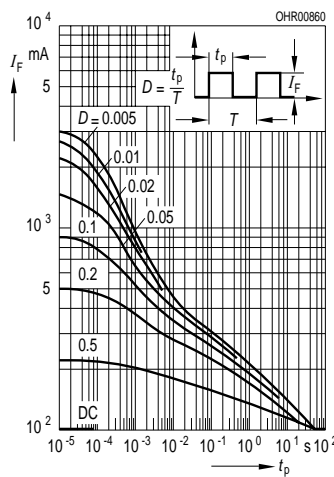

**Radiation Characteristics**  $I_{rel} = f(\varphi)$

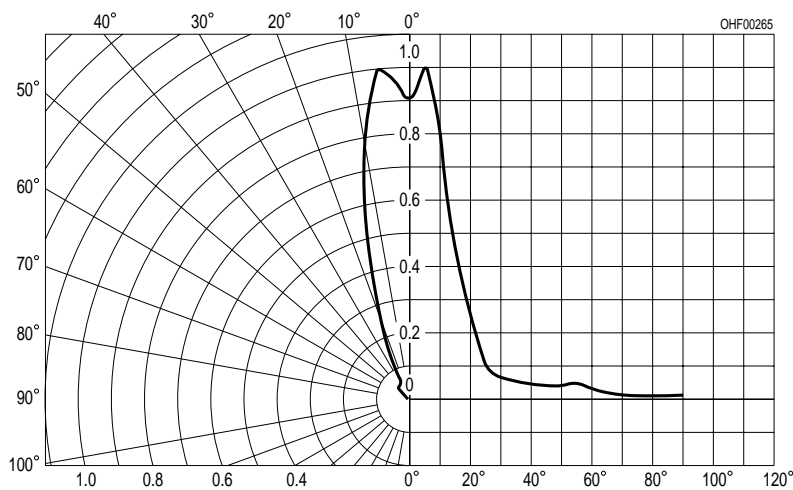

Maßzeichnung  
Package Outlines

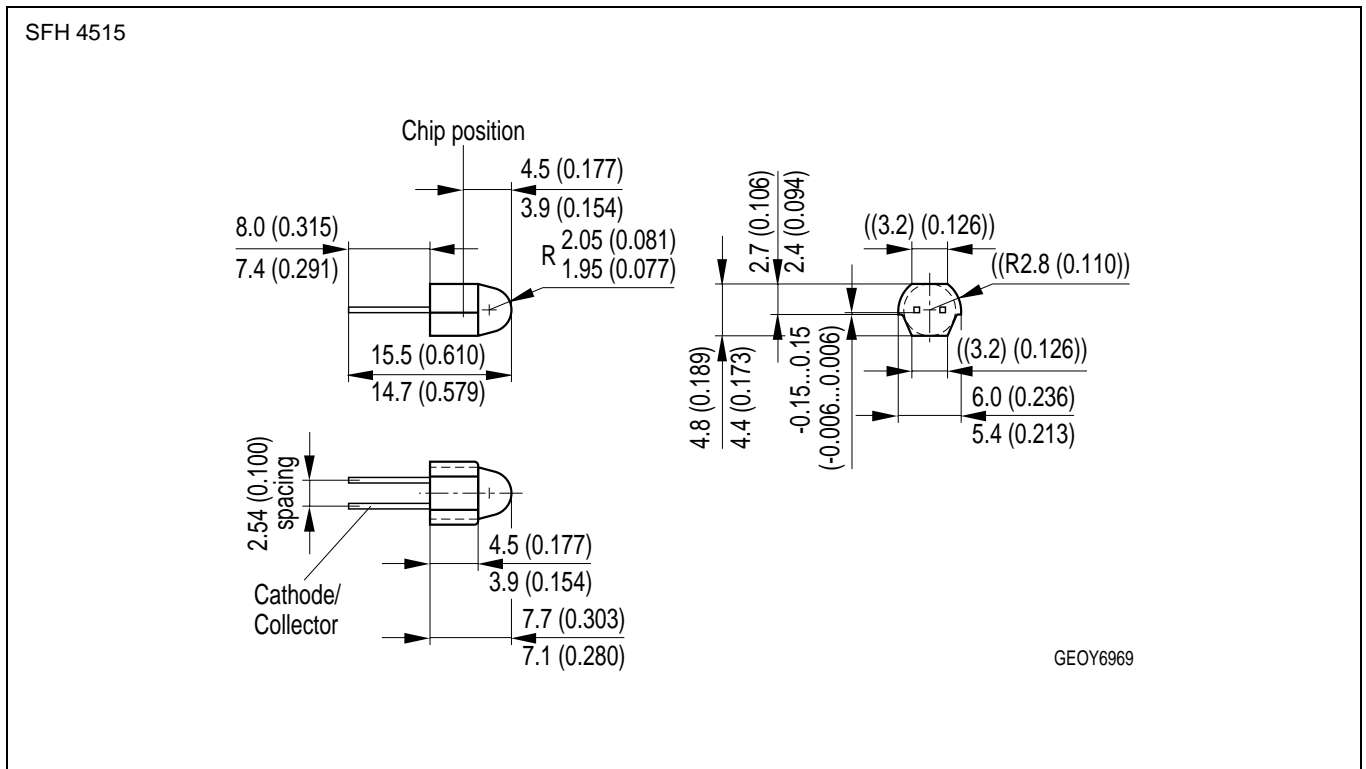
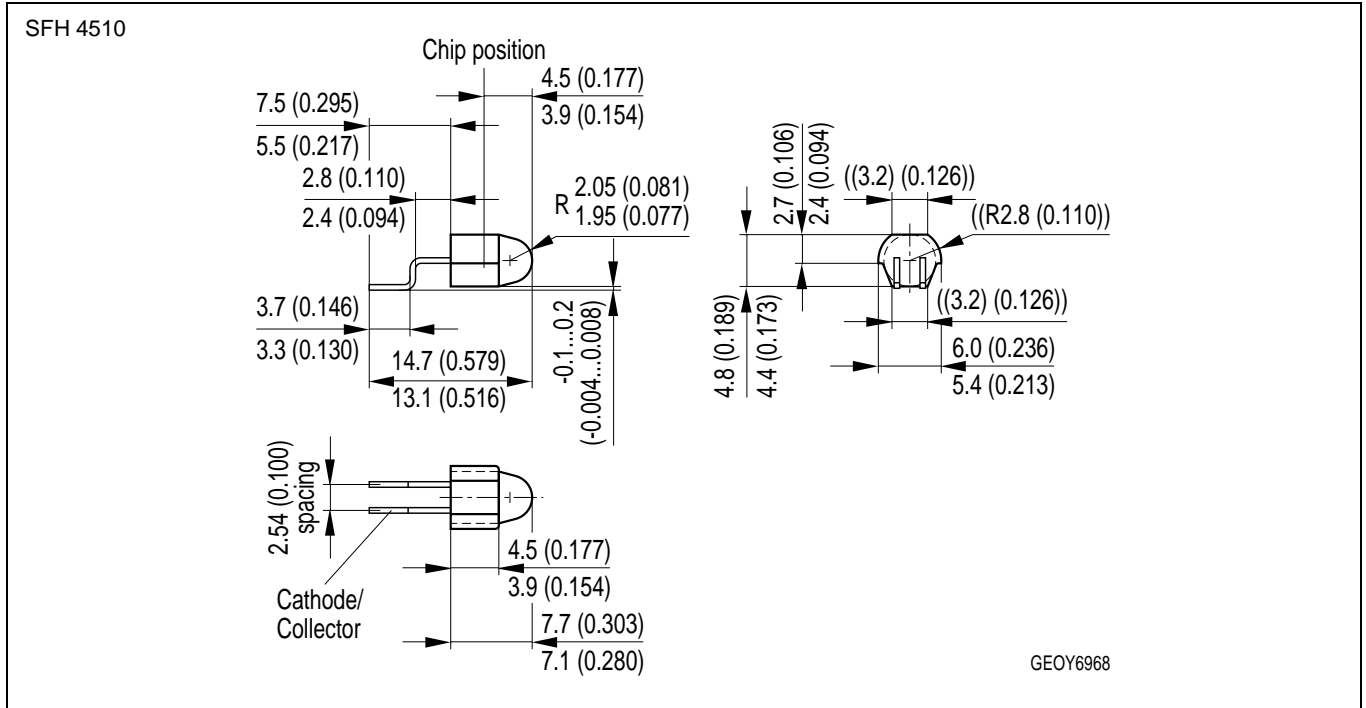

Maße werden wie folgt angegeben: mm (inch) / Dimensions are specified as follows: mm (inch).

**Published by OSRAM Opto Semiconductors GmbH & Co. OHG**  
**Wernerwerkstrasse 2, D-93049 Regensburg**  
**© All Rights Reserved.**

**Attention please!**

The information describes the type of component and shall not be considered as assured characteristics. Terms of delivery and rights to change design reserved. Due to technical requirements components may contain dangerous substances. For information on the types in question please contact our Sales Organization.

**Packing**

Please use the recycling operators known to you. We can also help you – get in touch with your nearest sales office. By agreement we will take packing material back, if it is sorted. You must bear the costs of transport. For packing material that is returned to us unsorted or which we are not obliged to accept, we shall have to invoice you for any costs incurred.

**Components used in life-support devices or systems must be expressly authorized for such purpose!** Critical components <sup>1</sup>, may only be used in life-support devices or systems <sup>2</sup> with the express written approval of OSRAM OS.

<sup>1</sup> A critical component is a component used in a life-support device or system whose failure can reasonably be expected to cause the failure of that life-support device or system, or to affect its safety or effectiveness of that device or system.

<sup>2</sup> Life support devices or systems are intended (a) to be implanted in the human body, or (b) to support and/or maintain and sustain human life. If they fail, it is reasonable to assume that the health of the user may be endangered.